



SmartStone[™]

Fabrication Manual

General Instructions

WARNING

Warning is used to indicate the presence of a hazard that can cause severe personal injury, death, or substantial property damage if the warning is ignored.

CAUTION

Caution is used to indicate the presence of a hazard that will or can cause minor personal injury or property damage if the caution is ignored.

NOTICE

Notice is used to note information that is important but not hazard-related.

Shipping & Storage

HANDLING A-FRAME

A fork lift truck with adequate loading capacity (approximately 5000kg) is essential for handling A-frames. It should be equipped with forks not less than 1.20m (48")/1.40m (56") in length for handling on the long side.

HANDLING RACK - A-FRAME ON THE LONG SIDE

We recommend inserting the forks into the rack in the holes provided

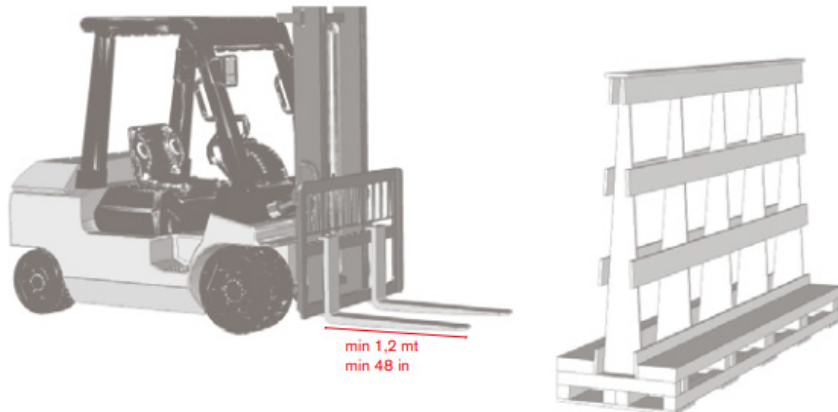

for this, using a fork lift truck of adequate load capacity equipped with forks at least 1.20m (48") in length, at the maximum obtainable width position. Before lifting, insert the forks all the way under the load.

WARNING

Tipping Hazard: For the safety of workers, to avoid injury to people and irreparable damage to the large porcelain panels, DO NOT handle the A-frames with forklifts after removing the plastic guards, strapping, and other anti-tip locking systems.

If even one of the anti-tip systems is removed, be sure to secure the load with appropriate systems, such as strapping or clamps, to prevent the large porcelain panels from tipping over.

Spring USA disclaims all responsibility for injury or damage to persons, property or to the large porcelain panels due to handling of A-frames without adequate safety guards in place. Spring USA recommends that, at all times, at least two, trained, workers handle any movement of the large porcelain panels.

HANDLING LARGE FORMAT CERAMICS

Handling single large format ceramics: During unloading, it is essential to remove large format ceramics one by one from alternate sides of the A-frame in order to ensure the load is stable, balanced and can be handled safely. Suction cup lifters, canvas or rubber belts, or clamps may be used to handle single large format ceramics.

Handling multiple large format ceramics: Use specific equipment with adequate load capacity. For example forklift with extending arms and sling straps, or overhead crane with jib and suitable straps. Steel cables, chains or anything that could damage the large format ceramics in any way should not be used. We recommend protecting edges when lifting or moving large format ceramics. Always check the maximum lifting capacity of the equipment is suitable for the weight of the load to be lifted.

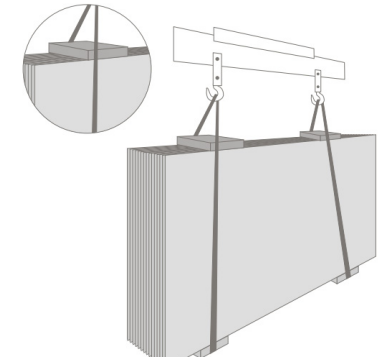

INSTRUMENTS REQUIRED

The instruments for lifting and handling the slabs can be chosen according to the size of the slab and the activities to be performed on the site, in particular:

- Fork lift truck with forks 1.6 M long;
- Frame with suction cups for handling large format slabs;

PROCESSING STAGES

1. Remove the cover from the cage/rack;
2. Position the frame with suction cups on the slab and make sure that the cups adhere to it perfectly;
3. For horizontal handling (on the surface), put the slab into a vertical position and use the wheels applied to the handling frame.

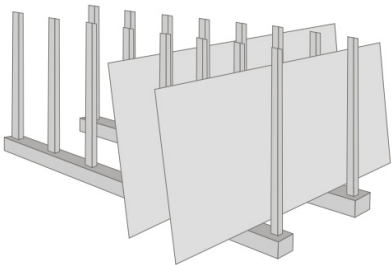

STORING LARGE FORMAT CERAMICS

Large format ceramics may be stored on trestles or in the shipping crates used to deliver products.

If storing on trestles, always ensure large format

ceramics are removed from alternate sides in order to balance the load, prevent damage and eliminate risk to personnel.

WARNING

After picking up large format ceramic(s) always ensure they are secured with straps or clamps, to prevent them possibly toppling over.

Alternatively, large format ceramics can be stored upright on suitable metal racks that must be covered with rubber, Teflon or wood on any parts in direct contact with large format ceramics. Bear in mind that, when stored upright on racks, the large format ceramics may flex slightly.

This does not affect installation since when laid on a flat surface any flexing should disappear and the large format ceramics will revert to being perfectly straight.

Design & Fabrication Guide

CUTTING AND CUTOUTS

Non-rectified large format ceramics must be detensioned, by making a small cut on all four sides, before starting to carry out any other work. We recommend using any type of cutter (disc, water jet, CNC etc.). We also recommend making cuts on the long sides first (1 and 2) followed by the short sides (3 and 4).

INSTALLATION INSTRUCTIONS:

We recommend wet cutting or the score and snap method during the installation process.

Do not dry cut using power tools during the installation process. Improper installation techniques could expose installer to harmful dust.

DISC CUTTING

Check the work bench is stable and flat. Select an appropriate disc taking into account the type of material to be cut (PORCELAIN STONEWARE), thickness, angle and type of machinery used.

At the end of the cutting line, we recommend using a quartz agglomerate or abrasive stone to prevent any chipping when the disc exits.

When cutting small pieces, it is good practice to fix them with an appropriate device to avoid any movement and consequent breakage. Reduce cutting speed to 50% at the beginning and end of cutting, for a length equal to the diameter of the disc used.

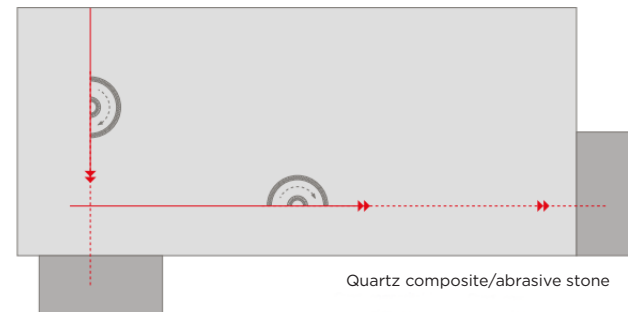

INTERNAL CUTS WITH DISC CUTTER FOR BASINS, COOKTOPS, ETC.

After having detensioned the large format ceramic around the entire perimeter, firstly make holes in each corner - minimum 35 mm (1.4 in) diameter holes are recommended. Then make 4 cuts on the large format ceramics starting with the longest cut and innermost one.

The cut must be at a tangent to the circumference of the hole, without going beyond it

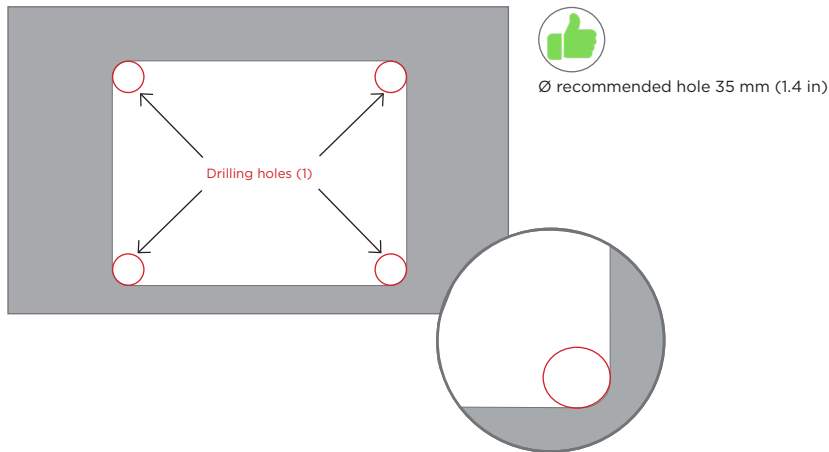

The minimum distance between the cut and the edge of the large format ceramic should not be less than 50 mm (2.0 in).

IMPORTANT:

- Use discs suitable for porcelain stoneware.
- The smaller the disc diameter, the greater the spindle rotation speed.
- A lower cutting speed creates a better quality cut.
- The disc must cut the entire thickness of the large format ceramic, going beyond it by at least 1mm (0.04 in).
- Check the work surface is straight, clean and stable.
- Cool the large format ceramic and disc thoroughly during cutting.
- Use plenty of water, making sure to direct the jet directly onto the cutting area.

THICKNESS	90° CUTTING FEED	DIAMETER DISC	MAX REVOLUTIONS
12 mm (0.48")	1,0 m/min	Ø 300 mm (11.8")	2100 - 2800
20 mm (0.80")	0,8 m/min	Ø 300 mm (11.8")	2100 - 2800
12 mm (0.48")	1,0 m/min	Ø 350 mm (13.8")	1900 - 2500
20 mm (0.80")	0,8 m/min	Ø 350 mm (13.8")	1900 - 2500
12 mm (0.48")	1,0 m/min	Ø 400 mm (15.8")	1500 - 2300
20 mm (0.80")	0,8 m/min	Ø 400 mm (15.8")	1500 - 2300
12 mm (0.48")	1,0 m/min	Ø 450 mm (17.8")	1200 - 2000
20 mm (0.80")	0,8 m/min	Ø 450 mm (17.8")	1200 - 2000
12 mm (0.48")	1,0 m/min	Ø 500 mm (19.8")	1000 - 1600
20 mm (0.80")	0,8 m/min	Ø 500 mm (19.8")	1000 - 1600

The values shown are indicative only and refer to an appropriate machine in good working order with adequate discs. For disc cutting, the operators expertise is vital in setting the parameters correctly, depending on the ceramics to be cut and the result required. It is also important to follow manufacturer's recommendations in respect of cutting discs.

WATER JET CUTTING

Spring USA large format ceramics can also be cut using a water jet cutter. It is advisable to set working parameters taking into account all factors such as: type of ceramics or porcelain being cut, the thickness and type of machine being used.

Cutting with a water jet enables perfect shapes to be obtained with clean, very accurate cuts.

Before starting to cut, check the flatness of the workbench and condition of supports.

We also recommend keeping the water level around 3 mm above the cutting surface supports.

When several openings need to be cut in large format ceramics, always cut the largest first followed by the smaller (for example: first the basin then the mixer tap).

We recommend drilling holes in the corners before any cutouts, in order to avoid excessive stress loading at the junction of cuts.

The minimum distance between cutouts and outer edge or between cutouts is as stated previously (min. 50 mm/2.0").

Water jet cutting requires perimeter contour cutting before starting the actual cut.

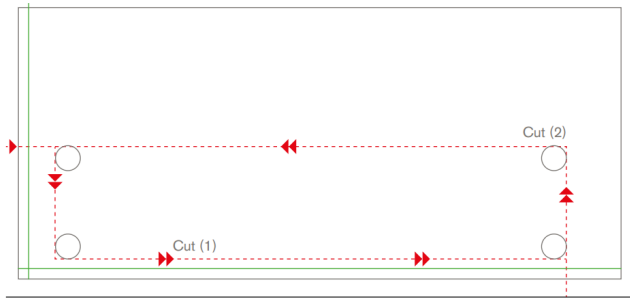
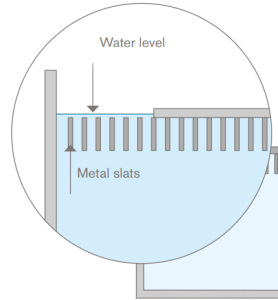

Ø ORIFICE	Ø NOZZLE	H ₂ O PRESSURE (HIGH) MPA	H ₂ O PRESSURE (LOW) MPA	ABRASIVE FLOW KG / MIN	ABRASIVE TYPE
0,3048 mm 0.012"	0,3048 mm 0.012"	380	103	0,32 (11.25 oz)	Granato #80

SPEED MT/MIN	
Thickness 12 mm (0.48")	0,7 - 1.0
Thickness 12 mm (0.48")	0,7 - 1.0

Reduce the speed by 20-30% for cuts other than at a 90° angle.

The figures shown are indicative only and refer to an appropriate machine in good working order with adequate equipment. For water jet cutting, the operators expertise is vital in setting the correct parameters, depending on the ceramics or porcelain to be cut and the result required.

CNC CUTTING

Check the working surface is straight, clean and stable.

Position a suitable number of suction cups in order to give the best possible support to the large format ceramic surface.

Positioning the suction cups correctly and efficiently is essential for successful cutting, in order for them to support the areas most under stress during cutting.

Distribute the suction cups evenly, including on the section that will be removed, otherwise the cut section could flex before the end of the cut causing breakages and cracks which would make the large format ceramic unusable.

Use plenty of water sufficiently directed onto the machine tool.

The machine tool must be at least 1 mm larger than the thickness of the large format ceramic being cut.

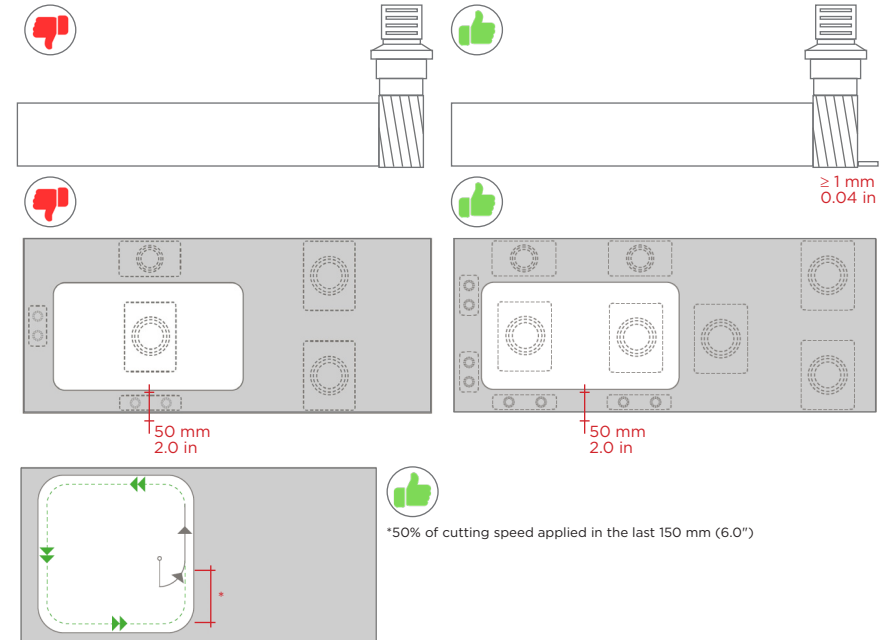

	SPEED MM/MIN	REVOLUTIONS / RPM	MAXIMUM REMOVAL
INITIAL HOLE Ø 35mm	10/15 mm (0.4 / 0.6")	4000/5000	
MILLING CUTTER Ø 19/22 MM	150/250 mm (6.0 / 9.8")	4000/5000	
FILLO TOP FINGER BIT	250/350 mm (9.8 / 13.8")	8000/10000	Max 3 mm (0.12") per pass

The figures shown are indicative only and refer to an appropriate machine in good working order with adequate machine tools. For CNC cutting, the operators expertise is vital in setting the correct parameters, depending on the ceramics or porcelain to be cut and the result required. It is also important to follow the manufacturer's recommendations in respect of cutting tools.

CAUTION

Finger Bit. do not use the swinging option while cutting as this may result in chipping. Rebate bit: Start by making a hole from which you can operate using the circular cutter. During the first of the two next passages remove 0.5 mm; later on, even the next 2 mm can be removed.

Positioning

HANDLING AFTER CUTTING

After completing all work on large format ceramics, take special care during handling, transport and installation at the client's premises. Most damage to the structure occurs during these phases, caused by flexing, twisting or impact on edges and corners.

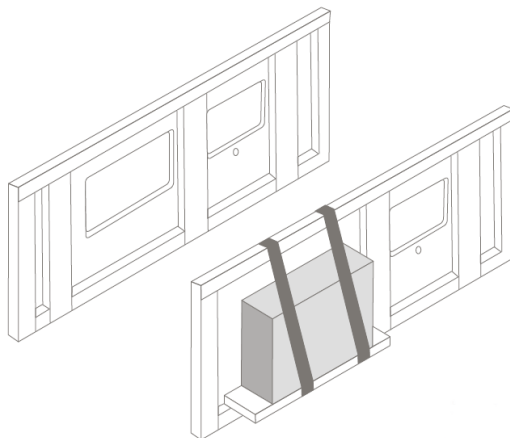

When there are large cutouts, or more than one cutout, we recommend installing wooden bars (50 x 30 mm/1.2"x2.0") along the entire length of the large format ceramic and also crossways, as per the diagram below to reduce the possibility of flexing (using hot glue to fix in place).

If the kitchen counter has a built-in basin assembled directly on the large format ceramic, provide support and fix the basin so that it cannot cause twisting or flexing.

APPROACHING THE PIECES

While approaching the slabs we recommend to follow the procedure below to guarantee the best possible positioning:

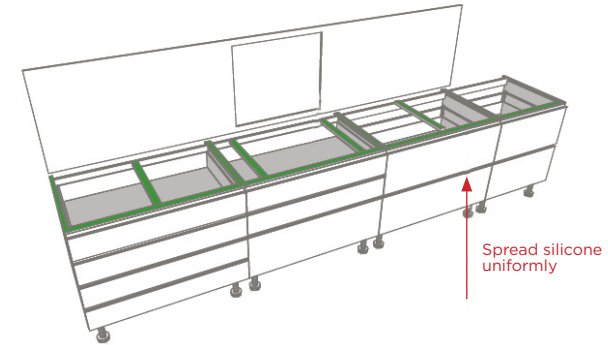

POSITIONING THE PIECES WITHOUT JOINT

Please handle the slabs carefully, with special caution to edges and keeping to the instructions below for their positioning:

1. Check that each edge is minimally chamfered to make the slab more solid;
2. Make sure that the substrate is leveled and perfectly flat, otherwise adjust or adapt using leveling wedges;
3. Check that the joint edges match perfectly and do not have different angles, which may cause breakage.

Leveling wedges must be inserted while approaching two adjacent slabs to avoid any impact.

The wedges can be removed only when silicone is applied and during possible later final adjustments that require a min. movement.

POSITIONING THE REINFORCEMENTS

It is recommended to build reinforcements to be placed on the slab rear side at a reciprocal distance of 600 mm (24.0").

Solid support is needed at least every 30" in order to provide a sturdy subframe for Smartstone material countertops. In the event the support



is missing, Spring USA has the right to void the warranty for tops without proper support. All joints must be reinforced in the lower part.

Gaps, not supported by any surface, must be reinforced with bars of a sufficiently resistant material, such as: granite, aluminum, high density polyurethane foam.

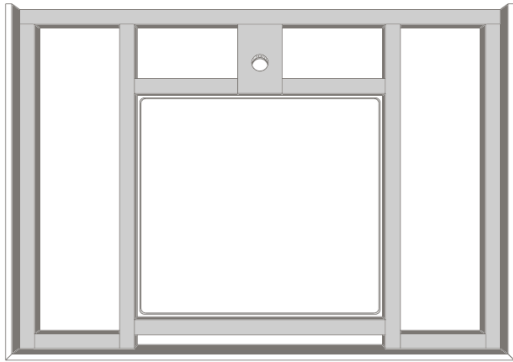

If the taps are to be installed directly in the top, it is advisable to add a reinforcing pad under the top in the point where the hole has been drilled. Be careful as the pad must be positioned so as to enable free movements of the top.

COUNTERTOP SUPPORT SUBSTRUCTURE

Before installing the top ensure that all parts of the cabinet structure are stable, level, clean and are able to support the load.

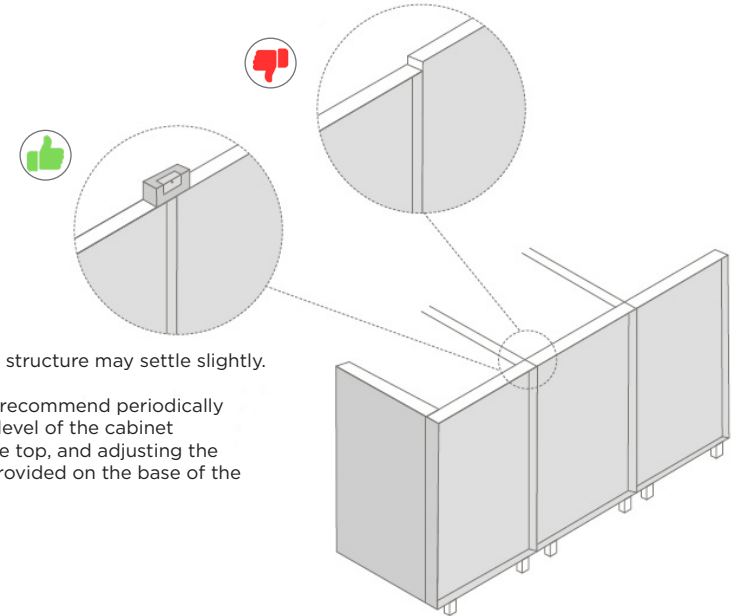
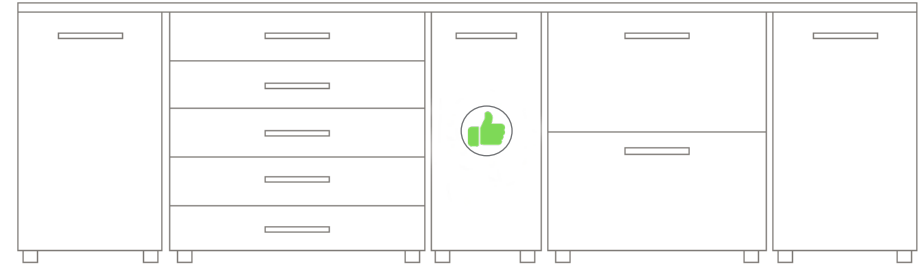
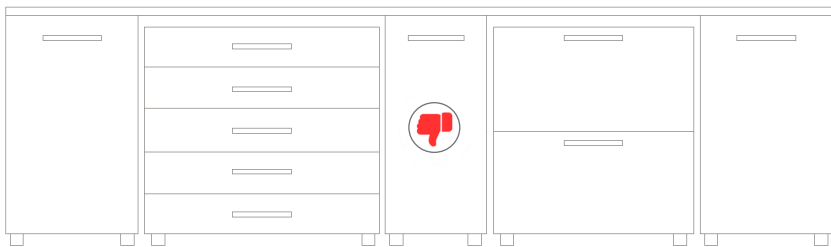
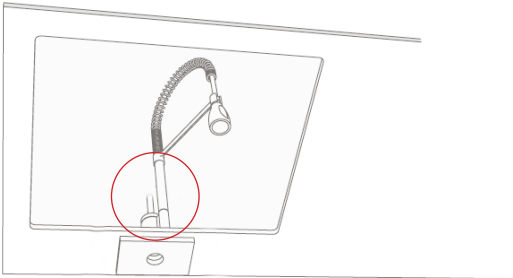

Over time the structure may settle slightly.

We therefore recommend periodically checking the level of the cabinet supporting the top, and adjusting the feet usually provided on the base of the cabinet.

BONDING THE TOP

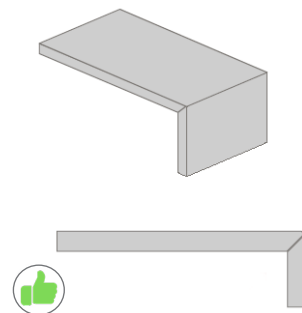

To bond porcelain stoneware parts (i.e. joints between vertical and horizontal pieces), use a two-part epoxy resin in the same color as the ceramics. Remove any excess two-part resin before it hardens. To bond the top to the structure use an flexible adhesive (i.e. silicone). For joints between set-in elements and the top use a transparent flexible adhesive (i.e. silicone) or the gaskets supplied with the basin or appliance.

It should look like this:

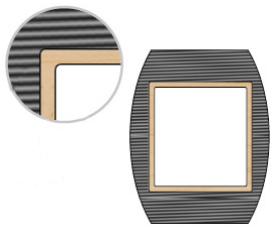

DO NOT Apply Thin-Set Mortar to the surface of the warming range.

Range Cutout Size

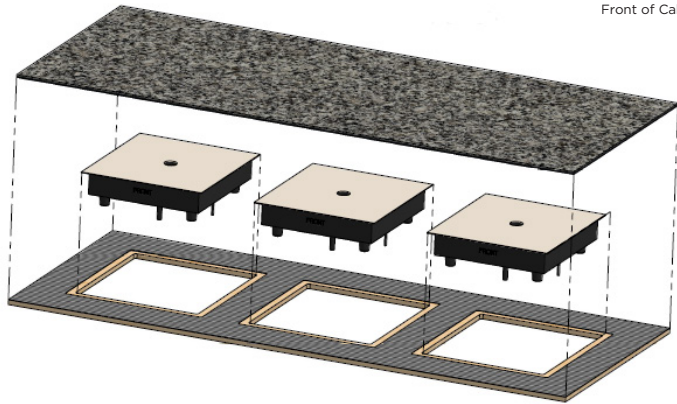
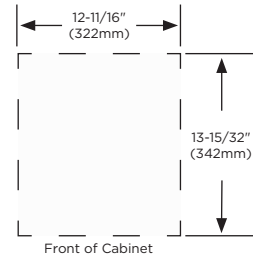

Place range into cutout and bracket.

Range Installation

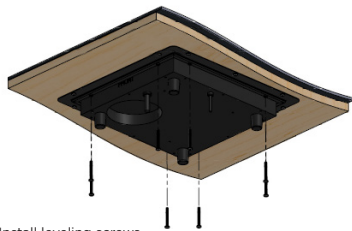

Install leveling screws

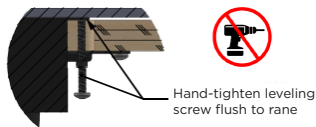

Hand-tighten leveling screw flush to range

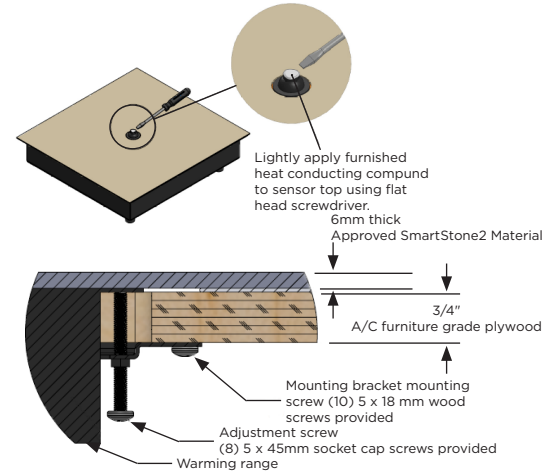

Cleaning After Cutting

Cutting/drilling large format ceramics, whether by water jet, disc or CNC, creates dust residues due to abrasion. This dust, when mixed with the water used during cutting, creates a mixture that tends to solidify when it dries. It is therefore essential to clean the surface thoroughly afterwards since, if not done correctly or at all, marks can be difficult to remove, especially on dark colors or gloss surfaces.

To clean the surface after cutting, use clean water and dry with a paper towel or, better still, a microfiber cloth. Repeat until the surface is completely clean. Do not store or stack cut large format ceramics when wet or not completely cleaned of residues.

Particular care should be taken to remove any epoxy resin residues on joints between vertical and horizontal large format ceramics, panels or basins.

Epoxy resin products adhere to surfaces rather than being absorbed, making removal after hardening somewhat difficult. It is essential to remove these residues when “fresh” using soft sponges, cloths and suitable cleaning products recommended by the manufacturers themselves.



Care and Maintenance

ORDINARY CLEANING

For ordinary cleaning it is sufficient to use a cloth in moistened microfiber and a neutral ph liquid detergent.

AVOID the use of abrasive sponges, steel wool pads, brushes hard and detergents containing hydrofluoric acid and its derivatives. Also avoid detergents containing waxes and / or brighteners.

EXTRAORDINARY CLEANING

For persistent stains, use a soft sponge and a specific cleaning product. It is very important not to let the cleaning product evaporate on surface. After using any type of cleaning products, always exercise a good rinse.

INFORMATION TO ENSURE SAFE USE

- It is always advisable to carry out a preliminary test on a concealed area or unused part of the large format ceramic.
- It is always good practice to remove all stains from the top promptly, especially particularly difficult stains such as coffee, red wine, juice, etc.
- On polished or natural surfaces do not use abrasive powder or paste detergents, abrasive sponges or steel scourers.
- In general, we recommend never using very strong acid or alkali cleaners.
- For dirt that is difficult to remove with a sponge or microfiber cloth, we recommend using a melamine sponge (commonly called a magic eraser).
- Our large format ceramics are resistant to thermal shock and scratching, however to maintain their appearance over time we recommend using trivets and chopping boards.



THE EVOLUTION OF INTELLIGENT DESIGN

127 Ambassador Drive, Suite 147
Naperville, IL 60540-4079
P: 630-527-8600
F: 630-527-8677
springusa@springusa.com
www.springusa.com